



USAID
FROM THE AMERICAN PEOPLE



Sida

FIRMA
Project BiH

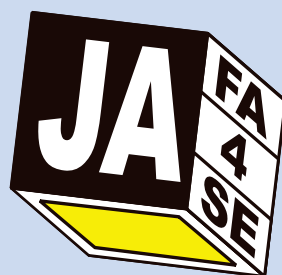

Jafa Jase 4

Proizvodnja prozora i vrata

Doors and windows production

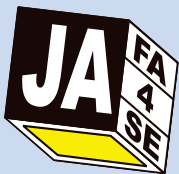

O nama

About us



Pet decenija duga porodična tradicija i bogato iskustvo u obradi drveta, pozicionirali su naše preduzeće na sami vrh ljestvice proizvođača stolarije u regiji. Povjerenje kupaca duže je od pola stoljeća, a mi smo ga gradili polako i oprezno, uvijek nudeći tržištu ono što je najbolje: kvalitet, garanciju, poštivanje rokova izrade...

Pratili smo svjetske trendove u dizajniranju i izradi vrata i prozora, vodeći se maksimalno da vrhunski majstori i u najtvrdem drvetu mogu pronaći dušu. Estetiku i funkcionalnost naših proizvoda, nametnuli smo kao svoj identitet na tržištu proizvođača građevinske stolarije. Zahvaljujući tome, postali smo respektabilan izvoznik u zemlje regiona sa plasmanom od oko 80 % svoje proizvodnje. Međutim, ostali smo u potpunosti odani svojim kupcima u Bosni i Hercegovini, gdje strpljivo gradimo svoju poslovnu mrežu. Izrađujemo proizvode po Vašoj želji, a ukoliko to želite, naši inženjeri predložit će najbolja rješenja za vaš stambeni ili poslovni objekat i dovesti Vašu ideju do pune realizacije, kojom ćete biti zadovoljni.

Dođite po najbolje rješenje!

Five decades long family tradition and rich experience in wood processing have placed us among top doors and windows producers in the region. We have our customers' trust for more than half a century, and we built it slowly and carefully, offering the best for the market: quality, guarantee, meeting deadlines...

We have kept up with the world class designing trends in windows and doors design and making, lead by the principle that top master carpenters can find a soul in the hardest wood. The esthetics and functionality of our products create our identity on the woods and windows market. Thanks to that, we have become a respectable importer into neighboring countries, exporting about 80% of our products. However, we have also been completely loyal to our customers in Bosnia and Herzegovina, where we are building our business network with patience. We are making products on demand, and, if you wish, our engineers will suggest the best solutions for your home or business object, bringing your idea to complete realization and making you satisfied.

Come and get your best solution!



Proizvodno-prodajni kompleks Jafa Jase 4 prostire se na 34.000 m² uz magistralni put Tuzla-Orašje, u naselju Špionica. To nam omogućuje da budemo komunikacijski veoma dobro povezani sa svim većim gradovima u BiH i državama u okruženju. Proizvodni kapaciteti su smješteni na 4.700 m² i omogućavaju značajno proširenje. Posjedujemo modernu tehnologiju za finalnu obradu drveta, te proizvodnju najkvalitetnijih vrata i prozora. Međutim, kao najvažniji segment našeg proizvodnog procesa i kompletne organizacije poslovnog društva, ističemo svoje uposlenike. Stalne edukacije, usavršavanje i predanost poslu, garant su našega kvaliteta i pozicije lidera na regionalnom tržištu.

Predanim radom na razvoju drvnog programa, uspjeli smo stvoriti široku paletu kvalitetnih, originalnih proizvoda. Prozore radimo u programu JJ4-Standard 56, JJ4-Soft 58 i JJ4-Soft 68, a posebno smo ponosni da smo među rijetkima u regionu, koji u svojoj ponudi imaju usvojenu proizvodnju drvo-aluminijum prozora, sa aluminijskim oblogama talijanskog proizvođača Olimpia.

Preduzeće Jafa Jase 4 u ponudi ima vrlo široku paletu ulaznih i sobnih vrata. Kada su u pitanju ulazna vrata, kupac može da izabere između programa 42 mm i 68 mm kao i vrstu drveta (jela/smrča, hrast, meranti...). Raspolažemo i izrazito bogatom ponudom sobnih vrata, program masiv i furnir...

Da bismo upotpunili našu ponudu i bili u stanju ispuniti sve zahtjeve naših kupaca, u proizvodnom programu smo usvojili i PVC stolariju, a u proizvodnji koristimo samo visoko certificirane PVC profile koji zadovoljavaju sve uvjete i standarde važeće u Evropskoj Uniji.

Production and sales complex of Jafa Jase 4 Company covers 34,000m² and it is situated near Tuzla-Orašje freeway, in Špionica. Such position helps us to have a good communicational connection with all larger cities in Bosnia and Herzegovina and in the neighboring countries. The production capacities are situated on 4,700m² with expanding possibilities. We have the cutting edge wood processing and windows and doors production technology. However, the most important segment of our production process and organization are our employees. Constant education, improvement and dedication are a warranty of our quality and leading position on the regional market.

Thanks to our dedicated work in the wood program development, we managed to create a wide line of quality and original products. Our windows are made according to program JJ4-Standard 56, JJ4-Soft 58 and JJ4-Soft 68. We are proud for the offer of wood-aluminum combined windows, coated with aluminum coatings by Italian manufacturer Olimpia.

Jafa Jase 4 offers a wide line of front doors and doors. When the front doors are concerned, a customer can choose between 42mm and 68mm programs and different types of wood (pine tree, juniper-tree, oak, meranti...). We also offer a wide line of doors, programs massive and veneer.

In order to complete our offer and respond to customers' demands, we included the PVC doors and windows in our program, and within our production we use only certified PVC profiles, which meet all conditions and standards valid in EU.



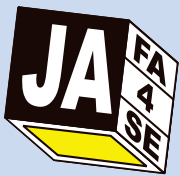

Prozori

Windows

JJ4-SOFT 68

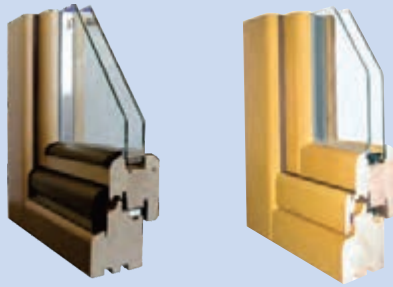

JJ4-SOFT 68 BELGIJA

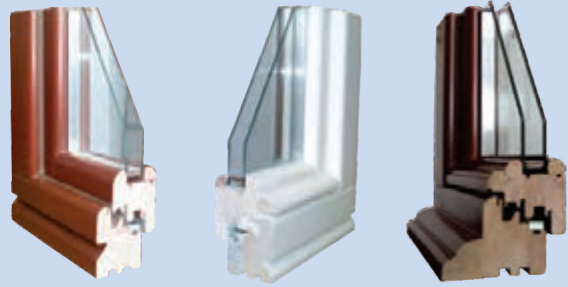

JJ4-CLASSIC IV 78

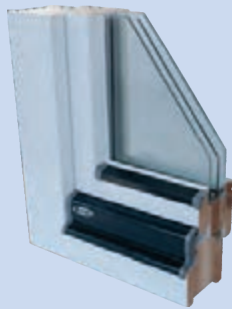

JJ4-DRVO-AL



JJ4-PVC W750

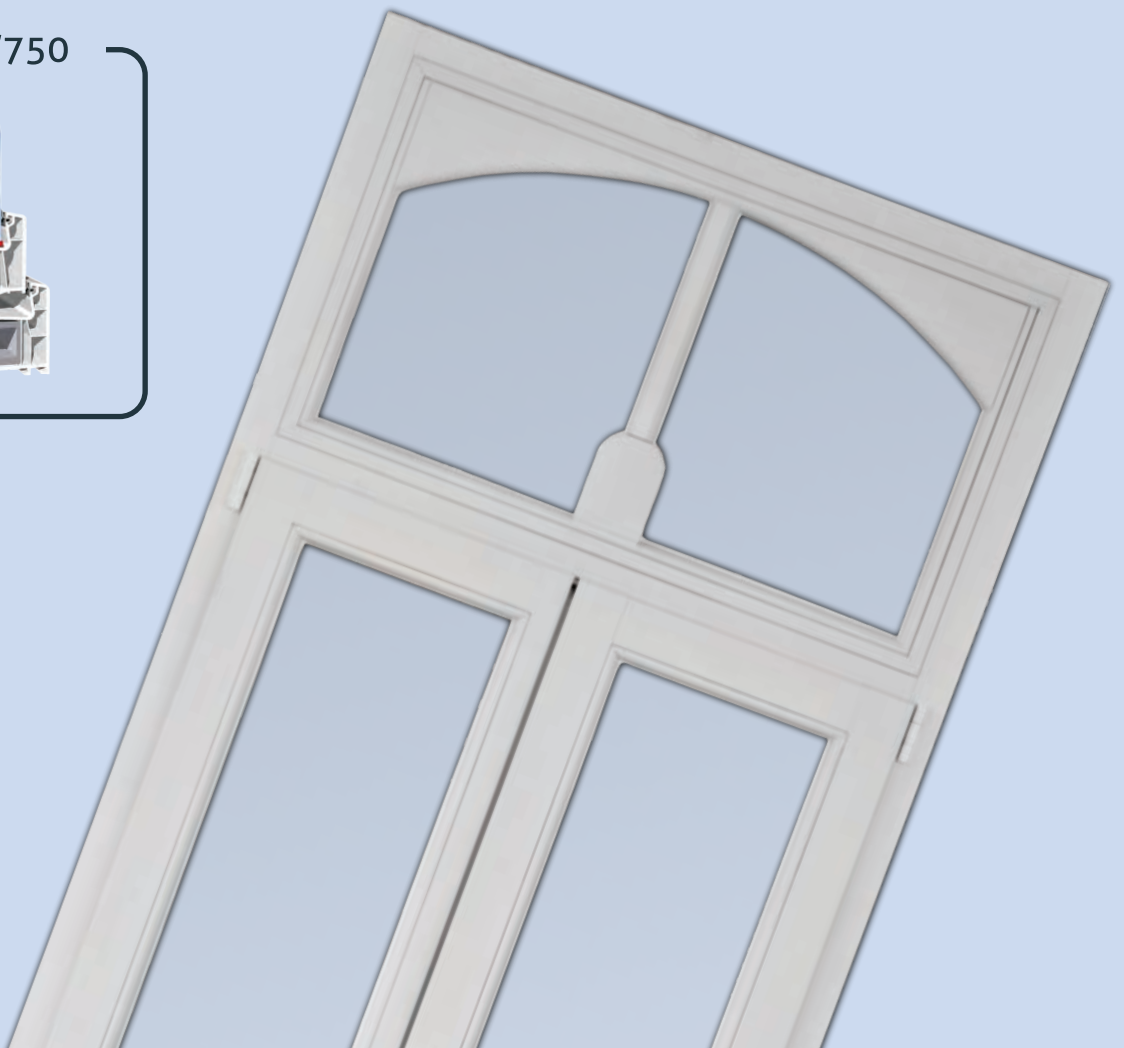

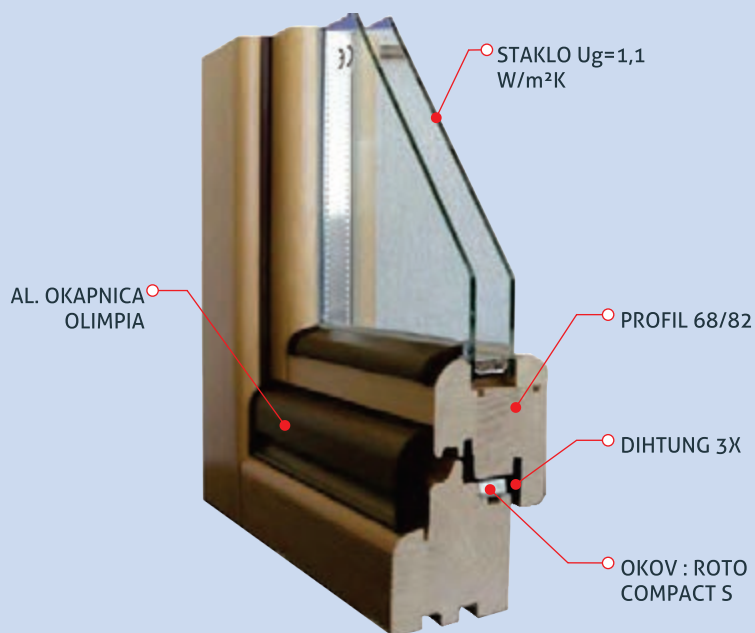

JJ4-SOFT 68

DRVO	Jela/Smrča, Ariš, B.Bor, Hrast, Meranti
STAKLO	28 -36 mm
BOJA	Sigma
OKOV	Roto compact S , Roto NT
Rw	32-38 dB
Ug	1.1-0,7 W/m² K

JJ4-SOFT 68

WOOD	Fir / Spruce, Larch, White Pine, Oak, Meranti
GLASS	28 -36 mm
COLOR	Sigma
MOUNT	Roto compact S , Roto NT
Rw	32-38 dB
Ug	1.1-0,7 W/m² K

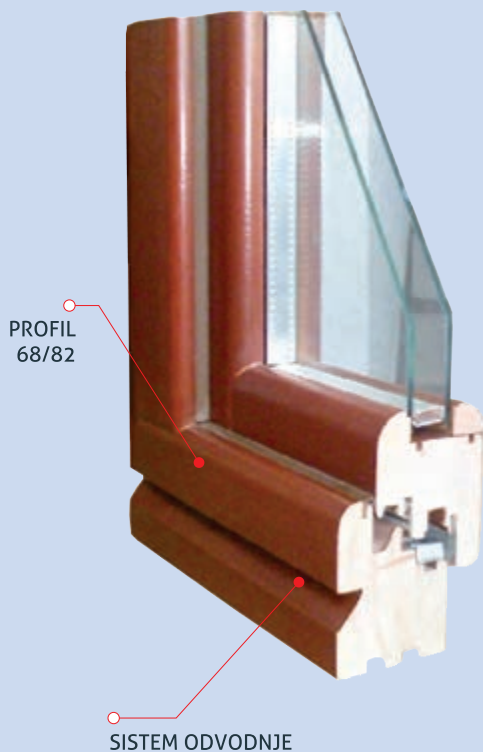

JJ4-SOFT 68 b

DRVO	Jela/Smrča, Ariš, B.Bor, Hrast, Meranti
STAKLO	28 -36 mm
BOJA	Sigma
OKOV	Roto compact S , Roto NT
Rw	32-38 dB
Ug	1.1-0,7 W/m² K

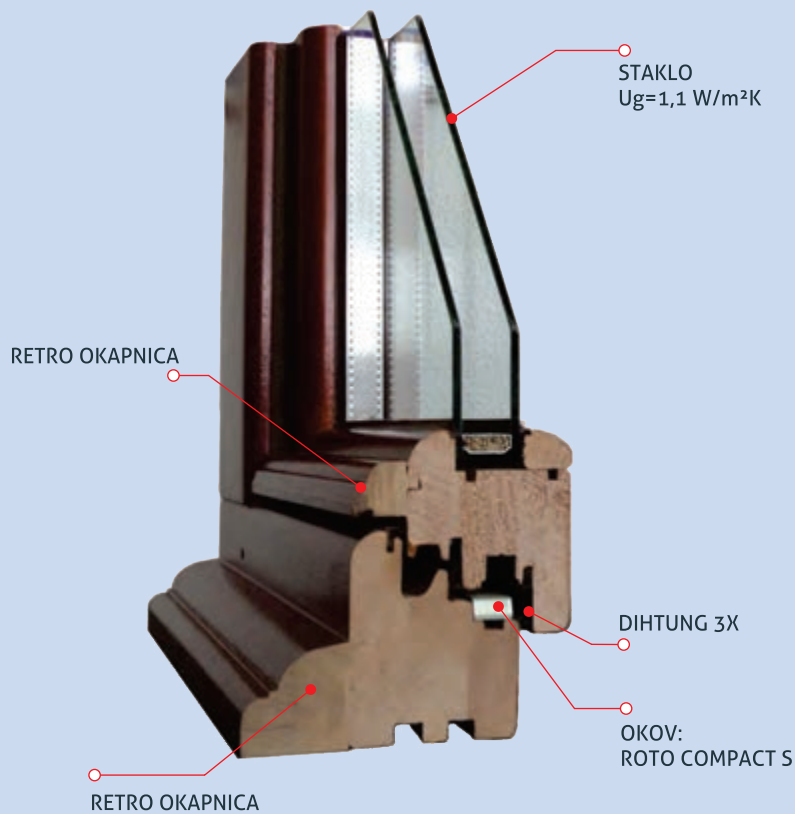

JJ4-SOFT 68 b

WOOD	Fir / Spruce, Larch, White Pine, Oak, Meranti
GLASS	28 -36 mm
COLOR	Sigma
MOUNT	Roto compact S , Roto NT
Rw	32-38 dB
Ug	1.1-0,7 W/m² K



PROFIL 78/82

AL. OKAPNICA
GUTTMAN

STAKLO
Ug=0,7 W/m²K

JJ4-CLASSIC IV78

DRVO Jela/Smrča, Ariš, B.Bor, Hrast, Meranti
STAKLO 36-40 mm
BOJA Sigma
OKOV Roto compact S , Roto NT
Rw 32-42 dB
Ug 0,7 , 0,6 W/m² K

JJ4-CLASSIC IV78

WOOD Fir / Spruce, Larch, White Pine, Oak, Meranti
GLASS 36-40 mm
COLOR Sigma
MOUNT Roto compact S , Roto NT
Rw 32-42 dB
Ug 0,7 , 0,6 W/m² K

DIHTUNG 2X-3X

OKOV: ROTO COMPACT S



AL. OBLOGA OLIMPIA
ASTRO 9 - 86 mm

JJ4-DRVO AL.

DRVO Jela/Smrča,Ariš,B.Bor,Hrast,Meranti
BOJA AL.OBLOGA Tigar RAL
AL.OBLOGA OLIMPIA sistem-ASTRO 9
STAKLO 36-40 mm
BOJA DRVO Sigma
OKOV Roto compact S , Roto NT
Rw 32-42 dB
Ug 0,7 , 0,6 W/m² K

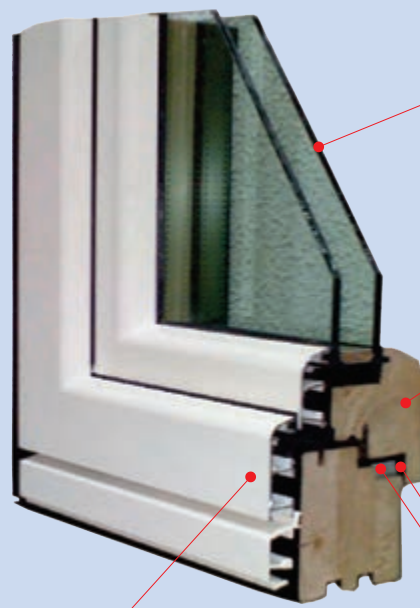

STAKLO Ug=0,7 W/m²K

PROFIL 68/82

DIHTUNG 2X

OKOV : ROTO COMPACT S

AL.OBLOGA OLIMPIA ASTRO 9 -
52mm

JJ4-DRVO AL.

WOOD Fir / Spruce, Larch, White Pine, Oak, Meranti
ALU COVERING Tigar RAL
COLOR OLIMPIA sistem-ASTRO 9
ALU COVERING OLIMPIA system-ASTRO 9
GLASS 36-40 mm
WOOD COLOR Sigma
MOUNT Roto compact S , Roto NT
Rw 32-42 dB
Ug 0,7 , 0,6 W/m² K

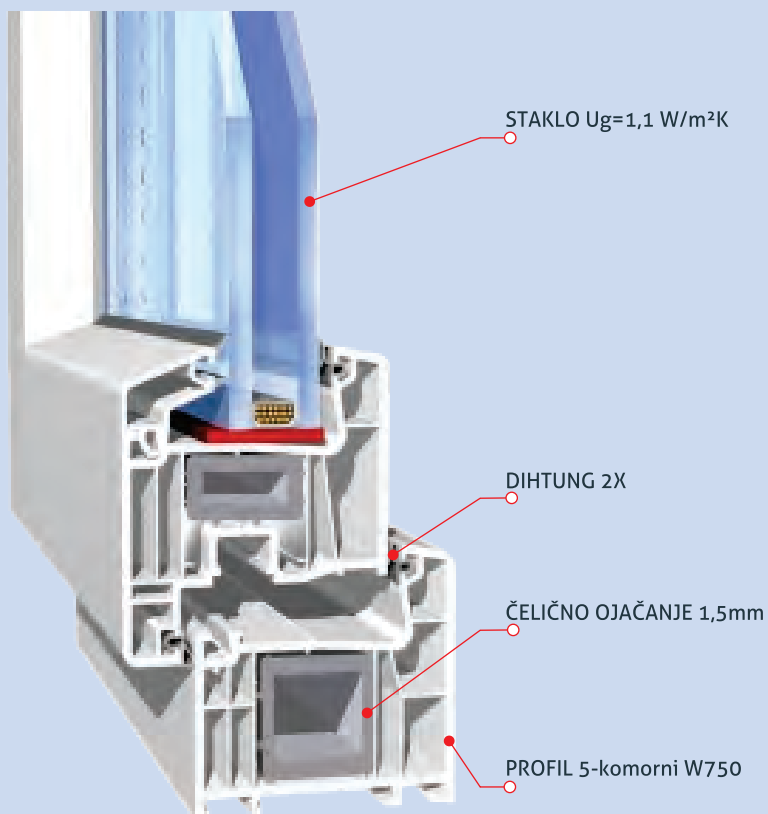
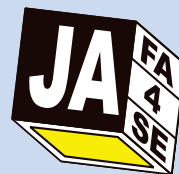

JJ4-PVC W750

PROFIL	Wintech W750
STAKLO	24-36 mm
BOJA	Bijela , Dekor
OKOV	Accado
Rw	32-38 dB
Ug	1,1 , 0,7 W/m² K

JJ4-PVC W750

PROFILE	Wintech W750
GLASS	24-36 mm
COLOR	White, Decor
MOUNT	Accado
Rw	32-38 dB
Ug	1,1 , 0,7 W/m² K



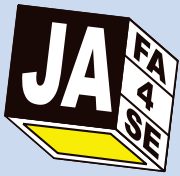

Klizno nagibna stijena PSK

- Okov Roto, boja pokrivnih profila: silver, bronza, bijela
- Maksimalna širina krila 1600 mm, visina od 1980-2380 mm
- Moguća izvedba u svim prozorskim sistemima

Tilting modulating cliffs PSK

- Roto Hardware, blast profile: silver, bronze, white
- The maximum width of wing 1600 mm the height of 1980-2380 mm
- Possible version in all windows systems

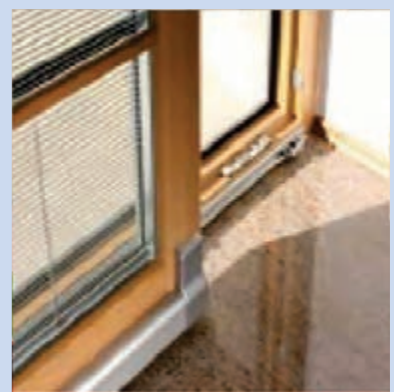
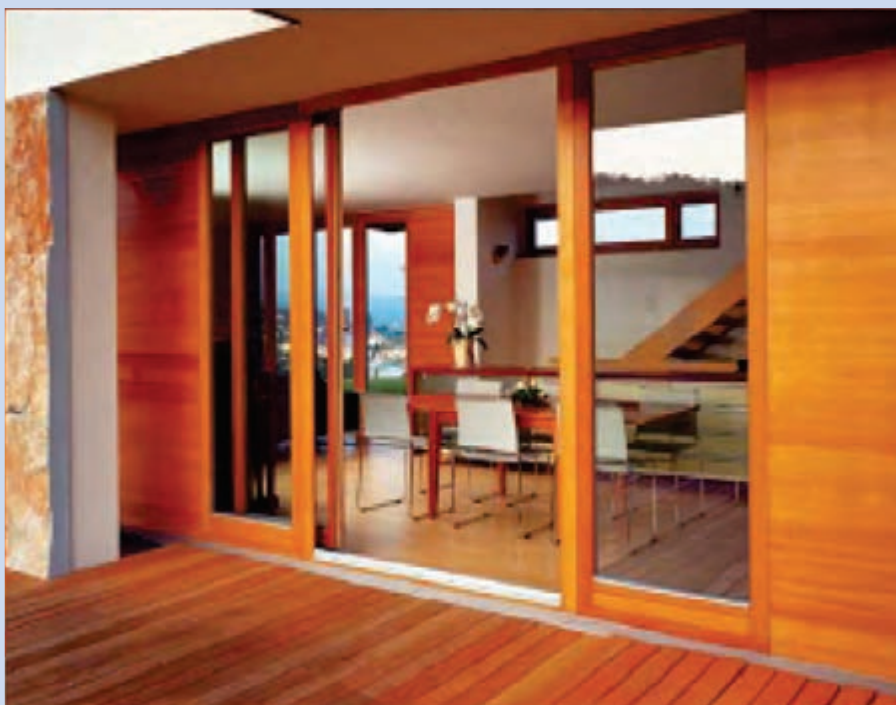



Podizno-klizne stijene HS

Okov MACO HS, boja pokrivnih profila smeđa, siva, bijela
 Prag: al. prag 20 mm, niski al. prag, drveni prag sa al. vodicom
 Moguća izvedba u svim prozorskim sistemima
 Stijene pogodne za veće otvore

Lift-sliding cliffs HS

Hardware MACO HS, blast profile brown, gray, white
 The doorstep: al. doorstep 20 mm, low al. doorstep, wood doorstep with al. Boom
 Possible version in all windows systems
 The cliffs are suitable for larger holes

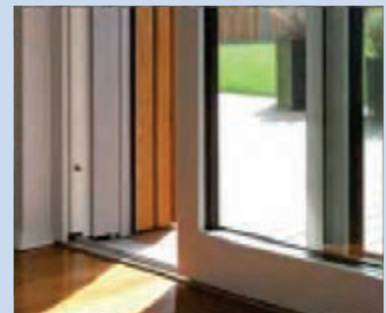
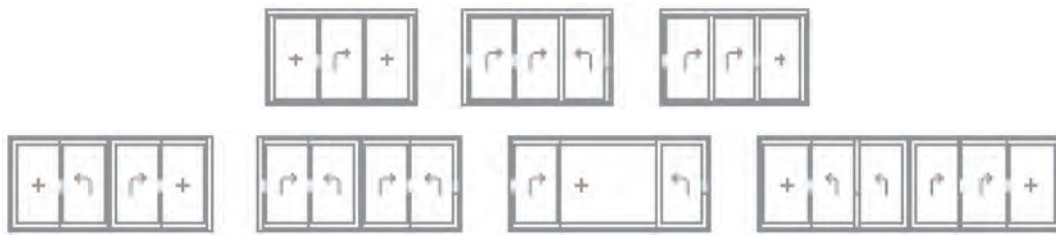

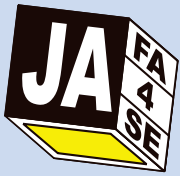

Staklo

Glass



4+20 ar + 4 low-e
6+20 ar + 6 low-e

Ug=1,1 W/m2 K
Ug=1,1 W/m2 K

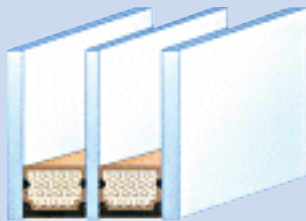

4+10+4 low-e +10+4low-e
4+12ar+4 low-e +12ar+4low-e
4+14ar+4 low-e +14ar+4low-e

Ug=0,9 W/m2 K RW dB=32
Ug=0,7 W/m2 K RWdB=33
Ug=0,6 W/m2 K RW dB = 33

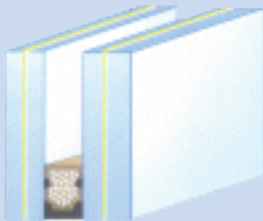

331+16 ar+331 low-e
331+16 ar+ 6 low-e
441+16 ar+441 low-e

Ug=1,1 W/m2 K RW dB= 39
Ug=1,1 W/m2 K RW dB=34
Ug=1,1 W/m2 K RW dB = 41





TON KARTA RENNER



TON KARTA SIGMA

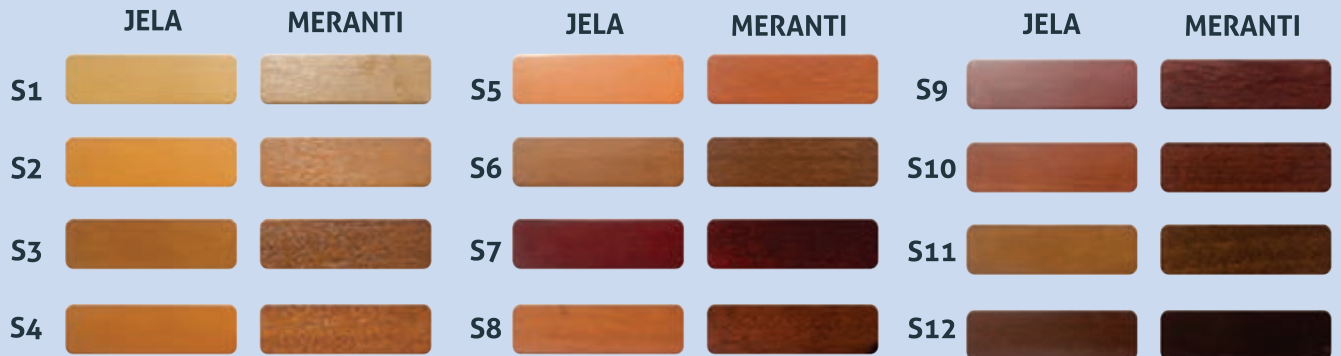

RAL karta boja

RAL 1000	RAL 1001	RAL 1002	RAL 1003	RAL 1004	RAL 1005	RAL 1006	RAL 1007
RAL 1011	RAL 1012	RAL 1013	RAL 1014	RAL 1015	RAL 1016	RAL 1017	RAL 1018
RAL 1019	RAL 1020	RAL 1021	RAL 1023	RAL 1024	RAL 1027	RAL 1028	RAL 1032
RAL 1033	RAL 1034	RAL 2000	RAL 2001	RAL 2002	RAL 2003	RAL 2004	RAL 2008
RAL 2009	RAL 2010	RAL 2011	RAL 2012	RAL 3000	RAL 3001	RAL 3002	RAL 3003
RAL 3004	RAL 3005	RAL 3007	RAL 3009	RAL 3011	RAL 3017	RAL 3013	RAL 3014
RAL 3015	RAL 3016	RAL 3017	RAL 3018	RAL 3020	RAL 3022	RAL 3027	RAL 3031
RAL 4001	RAL 4002	RAL 4003	RAL 4004	RAL 4005	RAL 4006	RAL 4007	RAL 4008
RAL 4009	RAL 5000	RAL 5001	RAL 5002	RAL 5003	RAL 5004	RAL 5005	RAL 5007
RAL 5008	RAL 5009	RAL 5010	RAL 5011	RAL 5012	RAL 5013	RAL 5014	RAL 5015
RAL 5017	RAL 5018	RAL 5019	RAL 5020	RAL 5021	RAL 5022	RAL 5023	RAL 5024
RAL 6000	RAL 6001	RAL 6002	RAL 6003	RAL 6004	RAL 6005	RAL 6006	RAL 6007
RAL 6008	RAL 6009	RAL 6010	RAL 6011	RAL 6012	RAL 6013	RAL 6014	RAL 6015
RAL 6016	RAL 6017	RAL 6018	RAL 6019	RAL 6020	RAL 6021	RAL 6022	RAL 6024
RAL 6025	RAL 6026	RAL 6027	RAL 6028	RAL 6029	RAL 6032	RAL 6033	RAL 6034
RAL 7000	RAL 7001	RAL 7001	RAL 7002	RAL 7003	RAL 7004	RAL 7005	RAL 7006
RAL 7008	RAL 7009	RAL 7010	RAL 7011	RAL 7012	RAL 7013	RAL 7015	RAL 7016
RAL 7021	RAL 7022	RAL 7023	RAL 7024	RAL 7026	RAL 7030	RAL 7031	RAL 7032
RAL 7033	RAL 7034	RAL 7035	RAL 7036	RAL 7037	RAL 7038	RAL 7039	RAL 7040
RAL 7042	RAL 7043	RAL 7044	RAL 8000	RAL 8001	RAL 8002	RAL 8003	RAL 8004
RAL 8007	RAL 8008	RAL 8011	RAL 8012	RAL 8014	RAL 8015	RAL 8016	RAL 8017
RAL 8019	RAL 8022	RAL 8023	RAL 8024	RAL 8025	RAL 8028	RAL 9001	RAL 9002
RAL 9003	RAL 9004	RAL 9005	RAL 9010	RAL 9011	RAL 9016	RAL 9017	RAL 9018

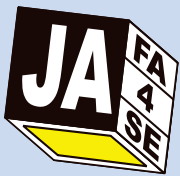

Maco Harmony



Maco Rhapsody

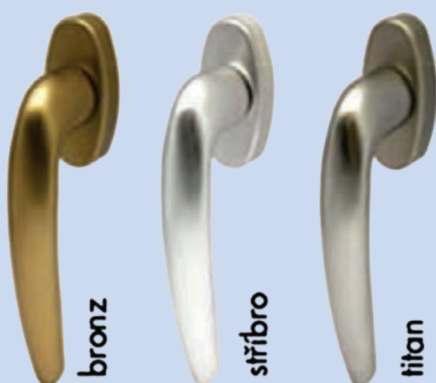

Hoppe Atlanta Secustic

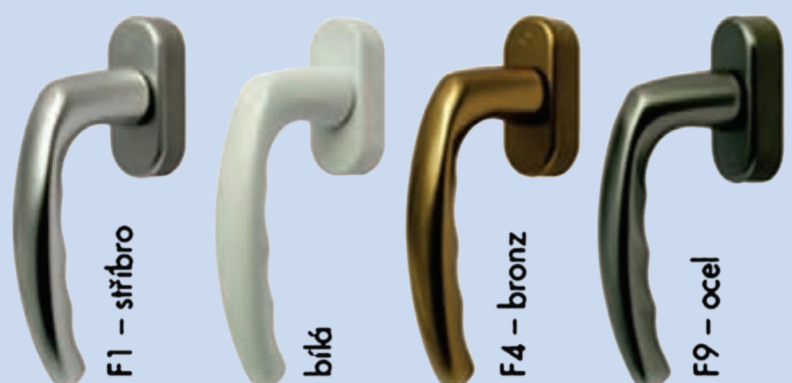

Maco Harmony



Hoppe Atlanta





MASIV CLASSIC 68

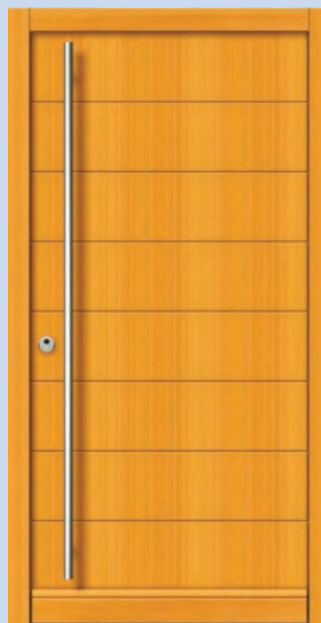

**PRESTIGE CLASSIC
PRESTIGE MODERN**



**DRVO-AL. PRESTIGE CLASSIC
DRVO-AL. PRESTIGE MODERN**



Masiv

Standardna izvedba masiv

Vrsta drveta- jela/smrča, hrast, meranti
 Dimenzija - širina 1000 - 1150 mm , visina 2000 - 2300 mm
 Debljina krila/štoka - 68 mm
 Staklo - termo izolacijsko iz skupine 1.1. W/m2K
 Okov - spojnica 3x , brava Maco 92/55, cilindar 40/50
 Prag - termoizolacijski al. prag Gutmman
 Okapnica - drvo 20/78
 Površinska zaštita - debeloslojna lazura Sigma

Standard version massive

Types of wood-fir / spruce, oak, meranti
 Dimensions - width 1000 - 1150 mm, the height 2000 - 2300 mm
 Thickness of wing / frame - 68 mm
 Glass - thermal isolation of the group 1.1. W/m2K
 Hardware - 3x hinge, lock Maco 92/55, cylinder 40/50
 The doorstep - thermal isolation al. doorstep Gutmman
 Dripline - Wood 20/78
 Coating - high build stain Sigma



Esmeralda



Standard style



Tinja

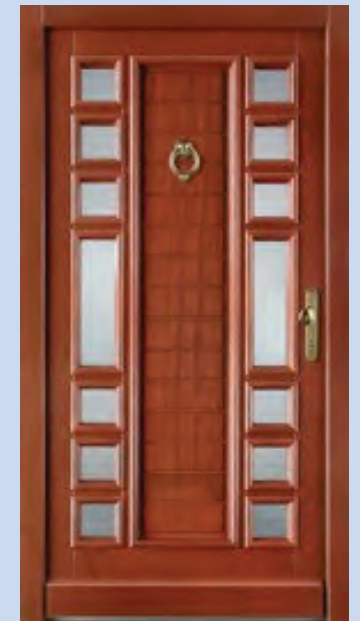

Ambijenta

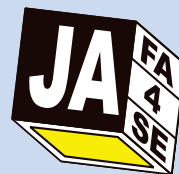

Masiv



Lepeza



Una



Belgija style



Sana



Sena



Temza

Prestige Classic - Prestige Modern

Tehnički detalji

Dichtung 2x

Al. ojačanje

Termoizolacijsko staklo

Višeslojna ploča AW100

PUR izolacija

ASS aluminijska parna brana

Termoizolacijski al. prag

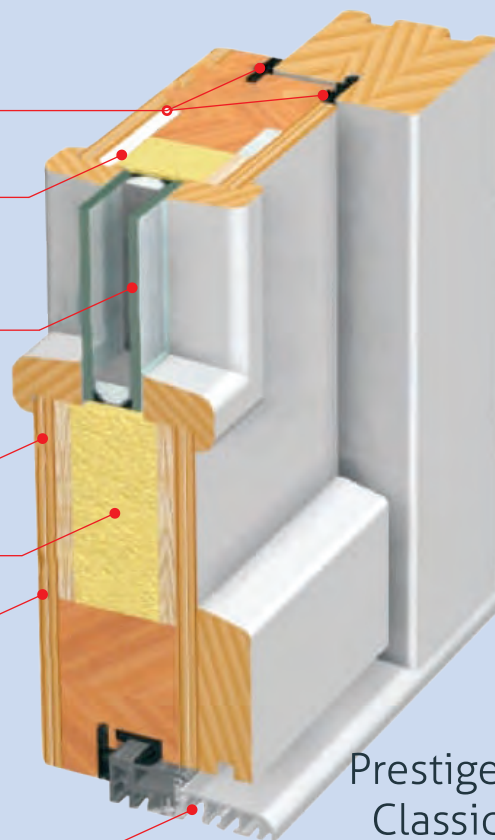

Prestige Classic



Prestige Modern

Standardna izvedba Prestige classic i modern

Vrsta drveta- jela/smrča, hrast, meranti
 Dimenzija - širina 1000 -1150 mm, visina 2000 - 2300 mm
 Debljina krila/štoka - 68 mm
 Staklo - termo izolacijsko iz skupine 1.1. W/m2K
 Okov - spojnica 3x , brava Maco 92/55, cilindar 40/50
 Prag - termoizolacijski al. prag Gutmman
 Okapnica - drvo 20/78 , aluminijski površinska zaštita - debeloslojna lazura Sigma

POSEBNA IZVEDBA VRATA PRESTIGE MODERN KRILO RAVNO SA ŠTOKOM.

Standard version Prestige Classic and Modern

Types of wood-fir / spruce, oak, meranti
 Dimensions - width 1000 - 1150 mm the height 2000 - 2300 mm
 Thickness of wing / frame - 68 mm
 Glass - thermal isolation of the group 1.1. W/m2K
 Hardware - 3x hinge, lock Maco 92/55, cylinder 40/50
 The doorstep - thermal isolation al. doorstep Gutmman
 Dripline - Wood 20/78, aluminium
 Coating - high build stain Sigma

SPECIAL DESIGN PRESTIGE MODERN DOOR STRAIGHT WING WITH LIVESTOCK



Prestige Classic - Prestige Modern

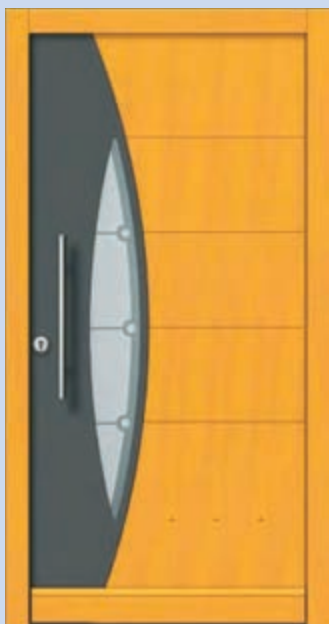

P1



P2



P3

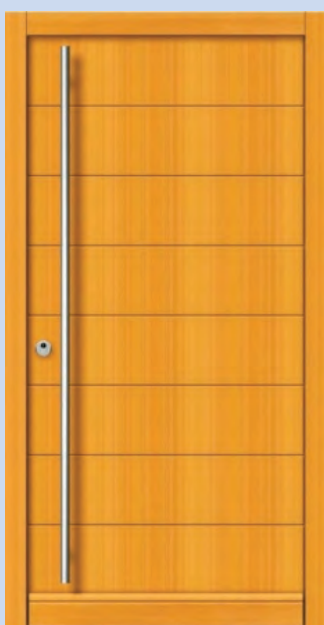

P4



P5



P6

Prestige Classic - Prestige Modern

Standardna izvedba drvo-aluminij Prestige classic I modern

Vrsta drveta- jela/smrča ,
hrast,meranti
Dimenzija - širina 1000-1150 ,
visina 2000-2300 mm
Debljina krila/štoka - 68 /85mm
Staklo - termo izolacijsko iz
skupine 1.1. W/m2K
Okov - spojnica 3 x , brava Maco
92/55,cilindar 40/50
Prag - termoizolacijski al.prag
Gutmman
okapnica - aluminijски
Površinska zaštita - debeloslojna
lazura Sigma
Površinska zaštita aluminija -
praškasto lakiranje po RAL karti
Aluminijсka obloga na krilu - 1-2
mm debljine

POSEBNA IZVEDBA VRATA
DRVO-ALUMINIJ PRESTIGE
MODERN
KRILO RAVNO SA ŠTOKOM



P8

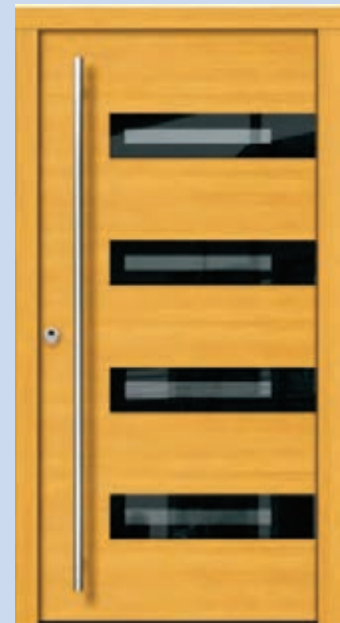

P9



P10



P11

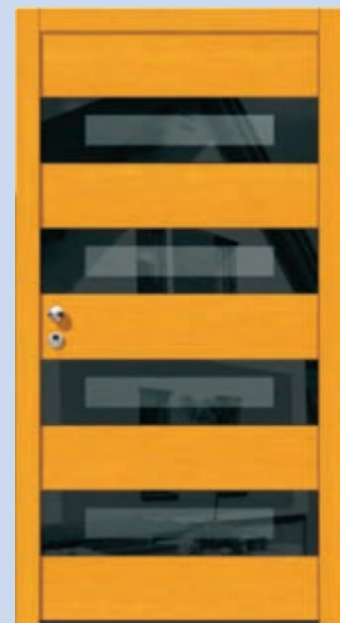

P12

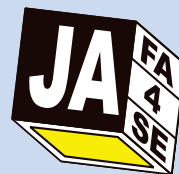

Drvo - Al.
Prestige Classic - Prestige Modern



PDA1

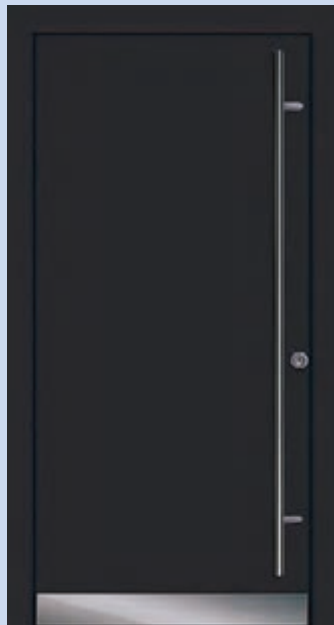

PDA2



PDA3



PDA4



PDA5



PDA6

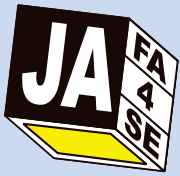

Ulazna vrata

Entrance doors

Drvo - Al.
Prestige Classic - Prestige Modern



PDA7



PDA8



PDA9



PDA10

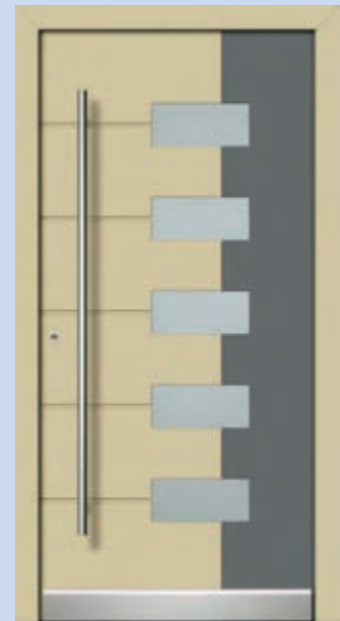

PDA11

Masiv

Krilo vrata:

Materijal

Okvir krila masiv drvo J/S obloženo MDF pločom 4mm, ispuna
MDF ploča, prirodni furnir 0.6mm/kant 1.5mm

Dihtung EPDM

Otvaranje: tradicionalna (jednokrilna vrata), dvokrilna vrata,
vrata sa pomoćnim štokom, klizna vrata, harmo vrata

Okov: brava 65mm, raspon os kvake i ključa 90mm, Φ15mm (za
tradicionalno otvaranje)

Boja: nitrobajc + transparentni P.U. lak sjaja 80%

ŠTOK/Dovratnik:

Materijal: MDF sa ojačanjem jela/smreka, furnir 0.6mm

Ukрасne lajsne: opšavne lajsne

Dihtung EPDM

Staklo: ornament pijesak 4mm

Silikon Transparentni neutralni

Okov Skrivene ili poluskrivene spojnice, prihvatnik za bravu

Boja Nitrobajc + transparentni P.U. lak sjaja 80%



Nejra 2



Nejra 1



Nejra 5



Nejra 3



Nejra 4



Nejra 6



Nejra 7



Nejra 8



Nejra 9



Nejra 11

Line

Krilo vrata:

Materijal: okvir krila masiv drvo J/S obloženo MDF pločom 4mm, ispunjena MDF ploča, prirodni furnir 0.6mm/kant 1.5mm
Dihnung: EPDM

Otvaranje: tradicionalna (jednokrakna vrata), dvokrakna vrata, vrata sa pomoćnim štokom, klizna vrata, harmo vrata
Okov: brava 65mm, raspon os kvake i ključa 90mm, Φ15mm (za tradicionalno otvaranje)

Boja: nitrobajc + transparentni P.U. lak sjaja 80%
ŠTOK/Dovratnik:

Materijal: MDF sa ojačanjem jela/smreka, furnir 0.6mm

Ukrasne lajsne: opšavne lajsne

Dihnung: EPDM

Staklo: ornament pijesak 4mm

Silikon: transparentni neutralni

Okov: skrivene ili poluskrivene spojnice, prihvatnik za bravu

Boja: nitrobajc + transparentni P.U. lak sjaja 80%



L1



L2



L3



L4



L5



L6



L7



L8



L9



L10

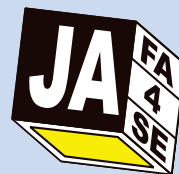

Modern line

Krilo vrata:

Materijal: okvir krila je izrađen od jela/smrča drveta, prekriven sa dvije MDF obloge 4mm, furnir 0.6mm/kant 1.5mm.

Strukturu punjenja čini stabilizacijski sloj papirno „saće“, opciono punjenje može biti i performirana iverica.

Dihung: EPDM

Otvaranje: tradicionalna (jednokrlna vrata), dvokrlna vrata, vrata sa pomoćnim krilom, klizna vrata, harmo vrata

Okov: brava 65mm, raspon os kvake i ključa 90mm, Φ15 mm

Boja: transparentni P.U. lak

Štok/Dovratnik:

Materijal: MDF sa ojačanjem jela/smreka furnir 0.6mm

Opšavne lajsne: masiv/hrast

Dihung: EPDM

Staklo: ornament pijesak 4mm

Silikon: transparentni neutralni

Okov: skrivene ili poluskrivene spojnice, prihvatnik brave

Boja: transparentni P.U. lak



ML 1

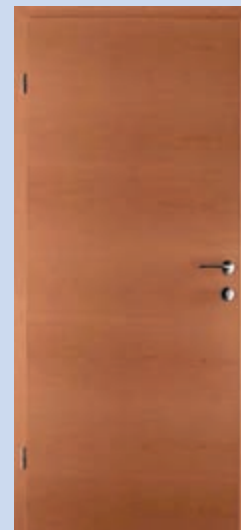

ML 2T

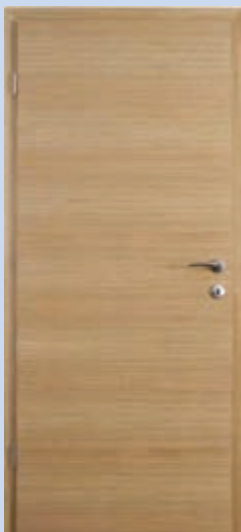

ML 2H

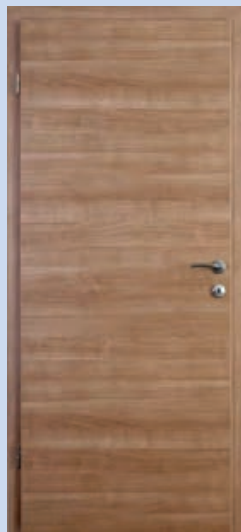

ML 20



ML 3

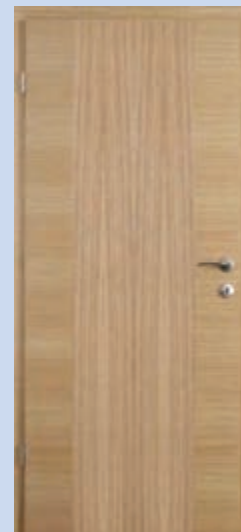

ML 4



ML 5



ML 6



ML 7

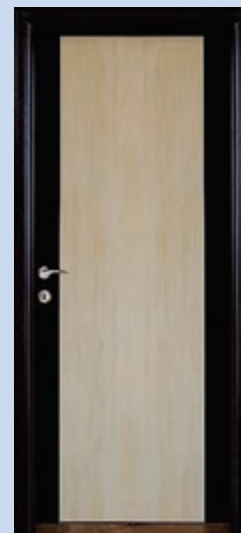

ML 7

Modern line



ML 8



ML 9



ML 10

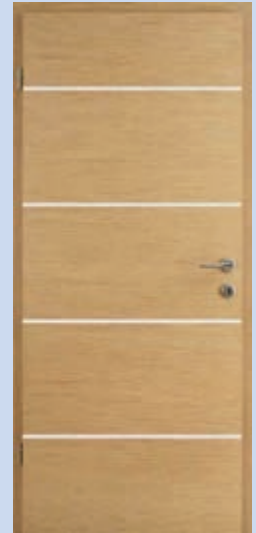

ML 11



ML 12



ML 13



ML 14



ML 15



ML 16



ML 11-K



MDF line

Krilo vrata:

Materijal: okvir krila je izrađen od jela/smrča drveta,

prekriven sa dvije HDF obloge 4mm

Strukturu punjenja čini stabilizacijski sloj papirno „saće“,

opciono punjenje može biti i performirana iverica.

Dihtung: EPDM

Otvaranje: tradicionalna (jednokrilna vrata), dvokrilna vrata,

vrata sa pomoćnim krilom, klizna vrata, harmo vrata

Okov: brava 65mm, raspon os kvake i ključa 90mm, Φ15 mm

Boja: transparentni P.U. lak

ŠTOK/Dovratnik:

Materijal: MDF sa ojačanjem jela/smreka -HDF 4 MM

Opšavne lajsne - HDF

Dihtung: EPDM

Staklo: ornament pijesak 4mm

Silikon: transparentni neutralni

Okov: skrivene ili poluskrivene spojnice, prihvatnik brave

Boja: RAL P.U. lak



MDF 1



MDF 2



MDF 3



MDF 4



MDF 5



MDF 6



MDF 7



MDF 8

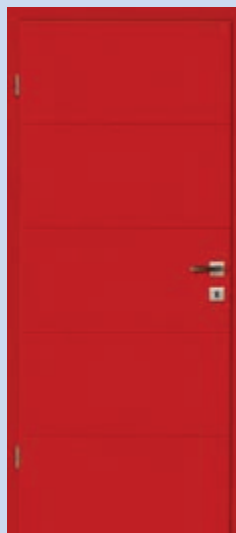

MDF 6 RAL



MDF 6 RAL

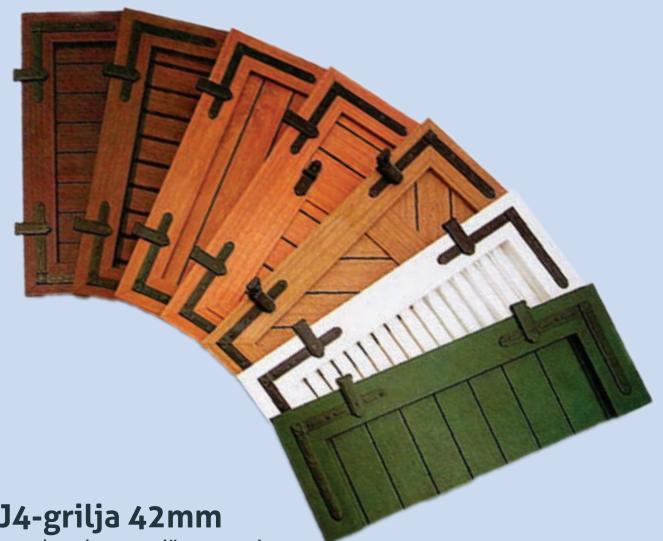

JJ4-grilja 42mm

Drvo: bor, hrast, ariš, meranti
Okov: maco rustico, roto arx
Boja - sigma coatings
Modeli - pokretne , fiksne
Lamele ,bolsena
,dalmatinska škura i kapci

JJ4-blinds 42mm

Wood: pine, oak, larch, meranti
Hardware: Rustico Maco, Roto ARX
Color - Sigma Coatings
Models - mobile, fixed
Lamellae, Bolsena, Dalmatian
shutters and blinds



PVC nadprozorska



45 predprozorska



Al nadprozorska



Ovalna - rondo predprozorska



JJ4-roletne

- Kutija - aluminijska i PVC
- Montaža - nadprozorska i predprozorska
- Modeli
 - AL. nadprozorska
 - PVC nadprozorska
 - Rondo predprozorska
 - 45 predprozorska
- Lamele - PVC I aluminijska
- Boja : bijela, dekori i RAL
- Pogon
 - manuelni
 - gurtna automat
 - kurbla
 - taster
 - daljinsko upravljanje
 - rolo komarnici
 - integrirani komarnici

JJ4-rolling shutters

- Box - Aluminum and PVC
- Installation - Above the window and in front the window
- Models
 - AL. above the window
 - PVC above the window
 - Rondo in front the window
 - 45 in front the window
- Lamellas - PVC and aluminum
- Color: White, decors and RAL
- The drive
 - manual
 - Flange machine
 - Bearing
 - taster
 - Remote control
 - Roller mosquito nets
 - Integrated mosquito nets

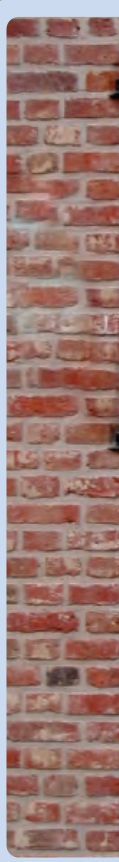
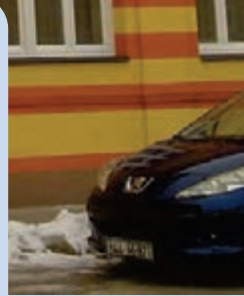

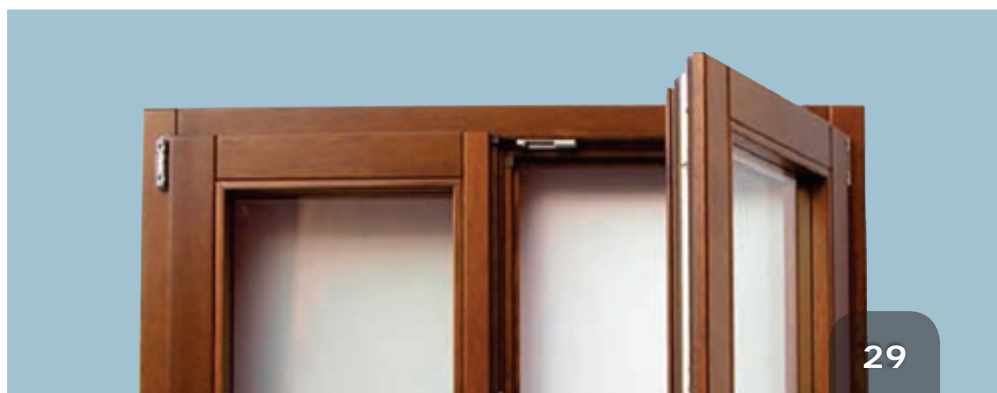
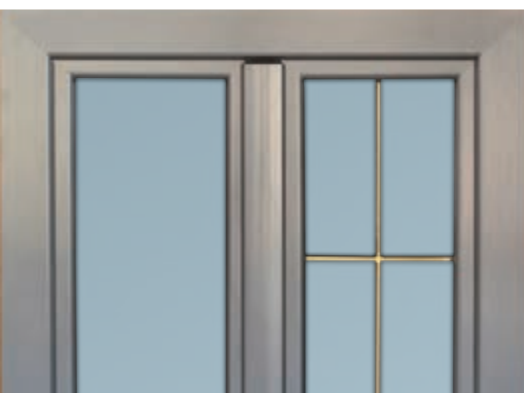

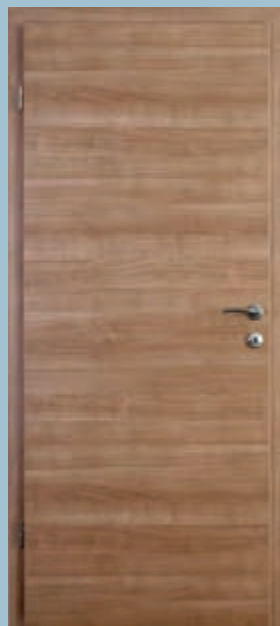

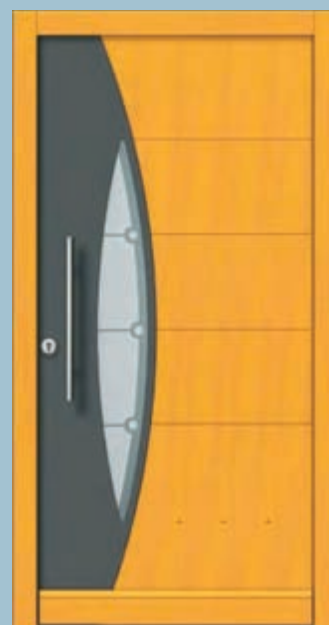

Izrada kataloga: BMG Bosanska medijska grupa, Tuzla
Tel: +387 35 360 715; e-mail: bmg@bmg.ba; www.bmg.ba

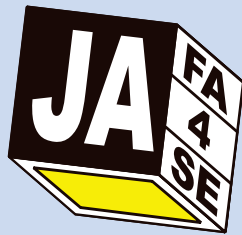

Jafa Jase 4 doo

Špionica bb,
75350 Srebrenik
Bosna I Hercegovina

Tel:

+387 35 649 754
+387 35 649 925

Fax:

+387 35 649 755

jafajase@jafajase.com
www.jafajase.com

Jafa Jase 4 doo

Špionica bb,
75350 Srebrenik
Bosna I Hercegovina

Tel:

+387 35 649 754
+387 35 649 925

Fax:

+387 35 649 755

jafajase@jafajase.com
www.jafajase.com